

TYPE: T2.0

Ambercon

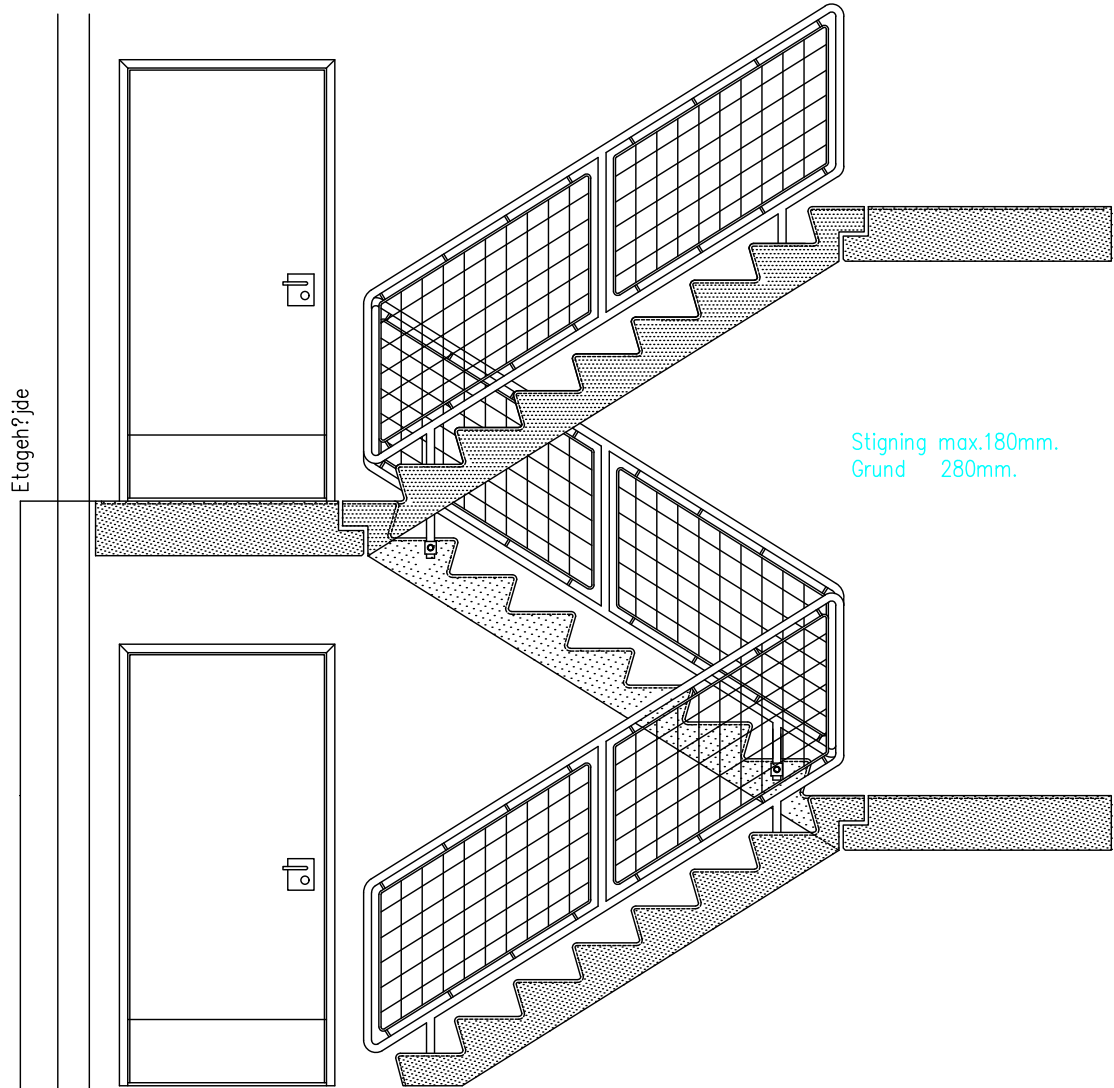

Opstalt af Trapperum

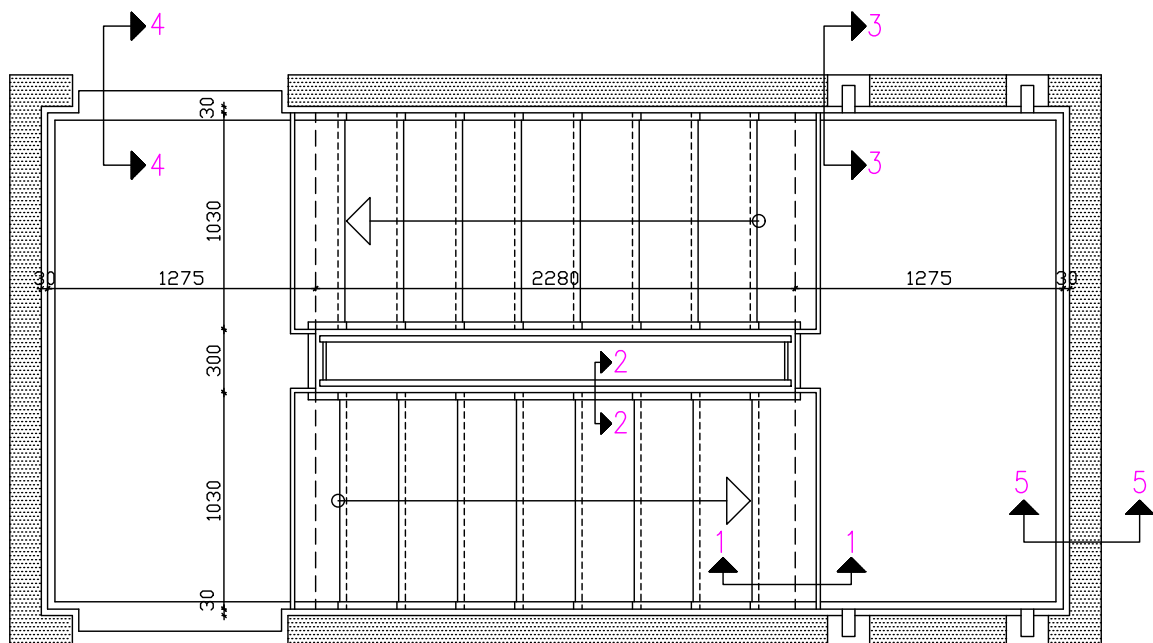

Plan of Trapperum

TYPE: T2.2

Ambercon

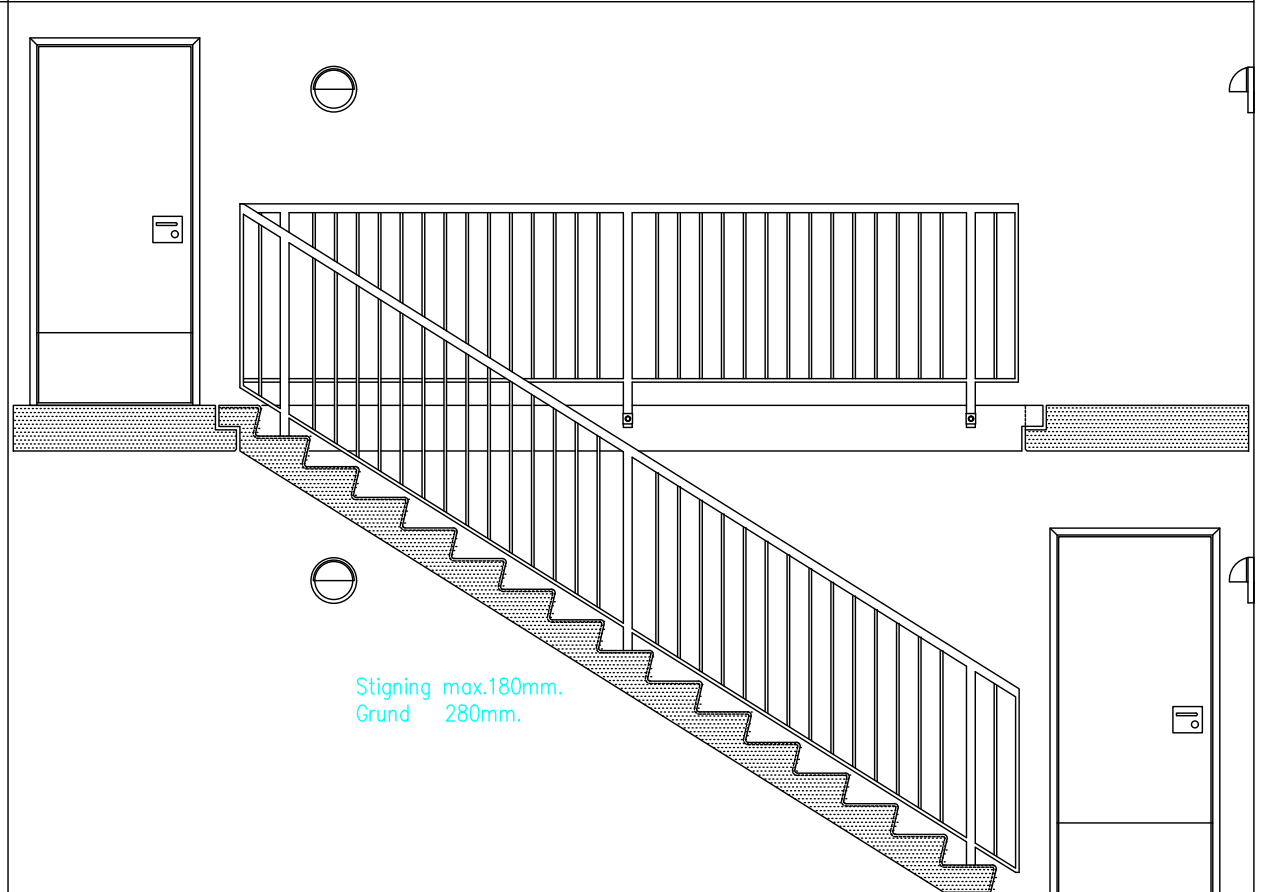

Opstalt af Trapperum

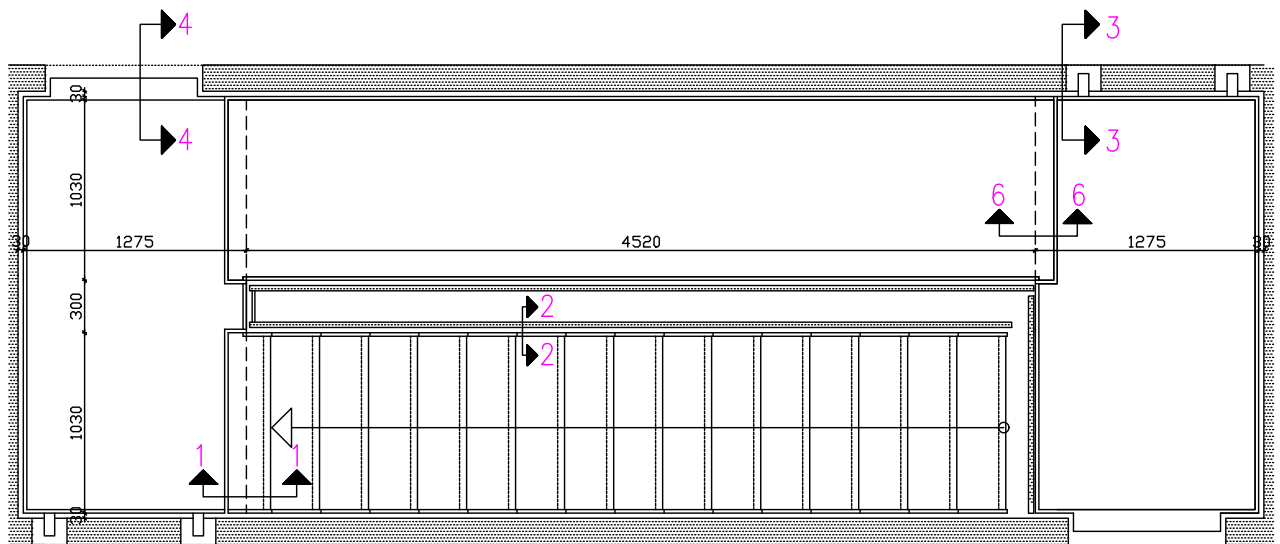

Plan af Trapperum



Samling med Trappe og Repos.

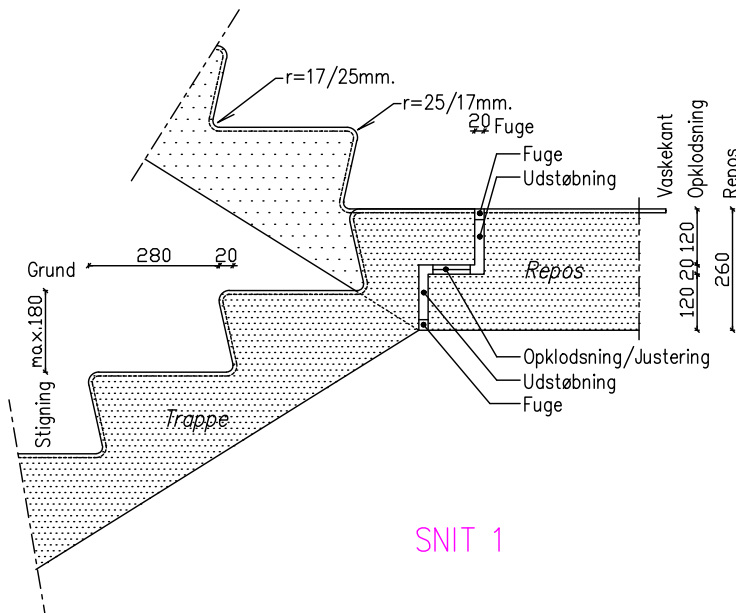

SNIT 1

Repos vederlag i dørudsp.

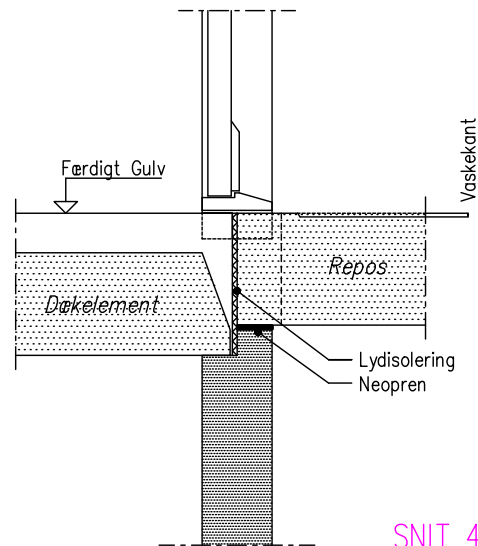

SNIT 4

Fastgørelse af gelænder til Trappeløb.

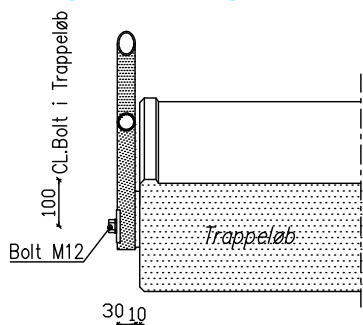

SNIT 2

Fuge ved Repos/Væg

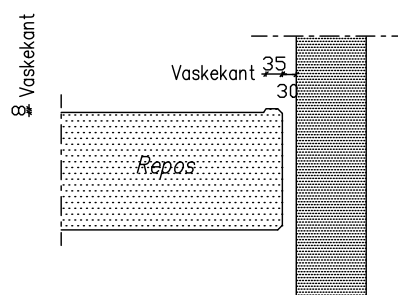

SNIT 5

Dornsamling mellem Repos og Væg.

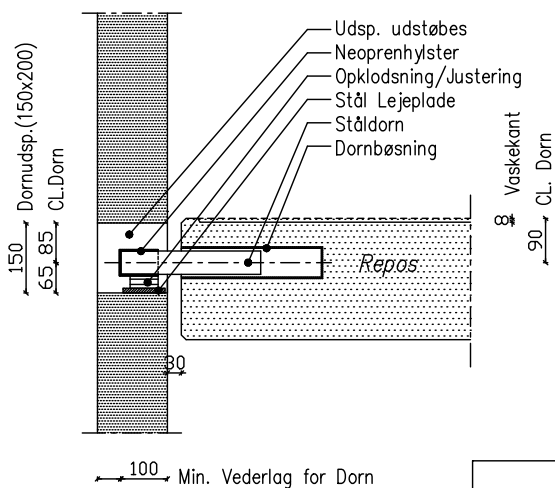

SNIT 3

Samling mellem Reposer.

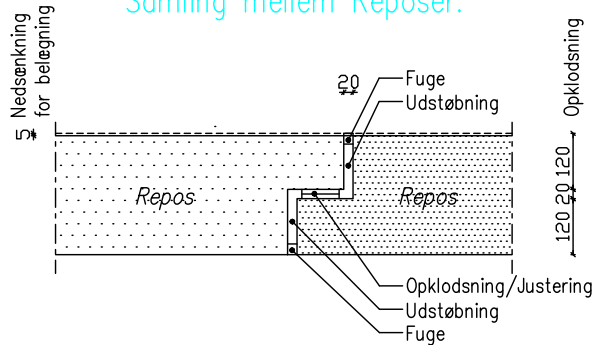

SNIT 6

Standard trappe Type T2 fås i varianter, der kan tilpasses trapperum med andre mål.